

Quick Reference Guide / Hotkeys



Hotkeys

„F5“ Zoom all

When you press the button "F5" everything is represented in the drawing window, what was drawn:

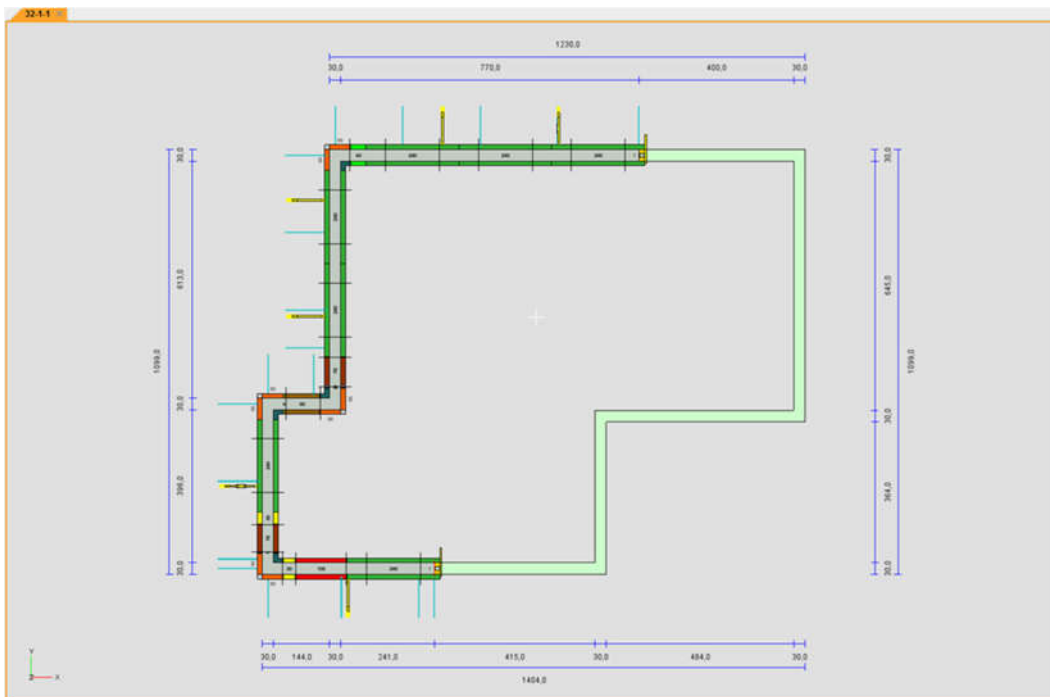
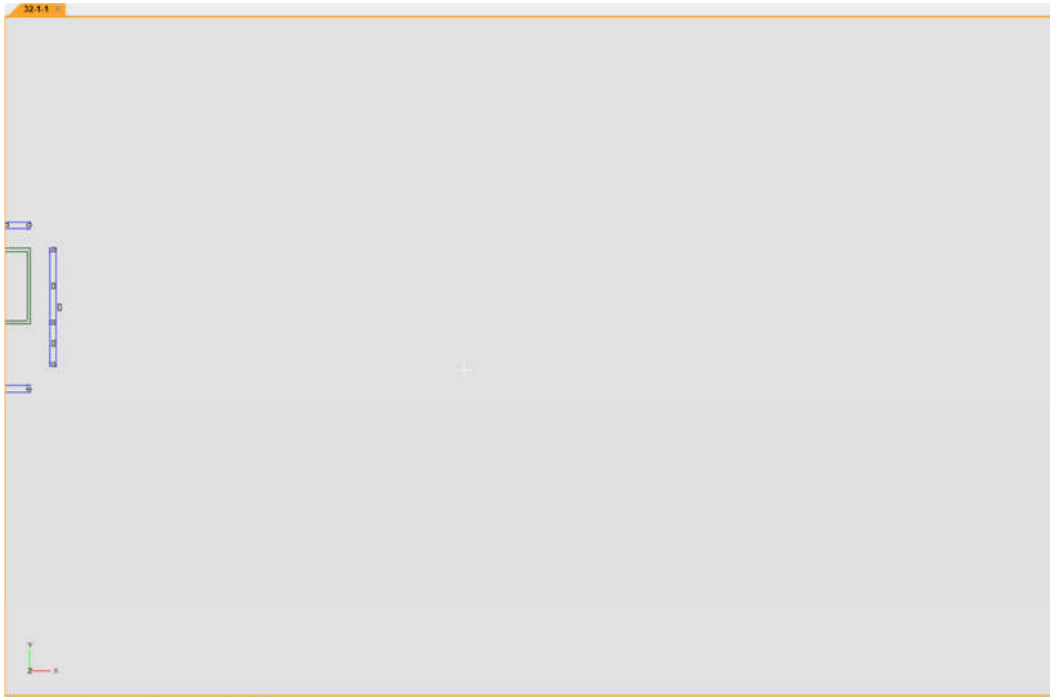

„F7“ Show – Change Phases

If you press the "F7" key, the mask "Show / Change Phases" will be opened:

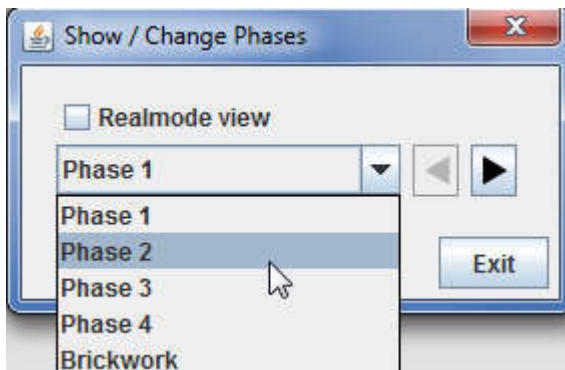
**„F8“ Show the active floor / Show the whole model**

With the key „F8“ the active storey can be displayed. When you press the button again, the entire model can be displayed:

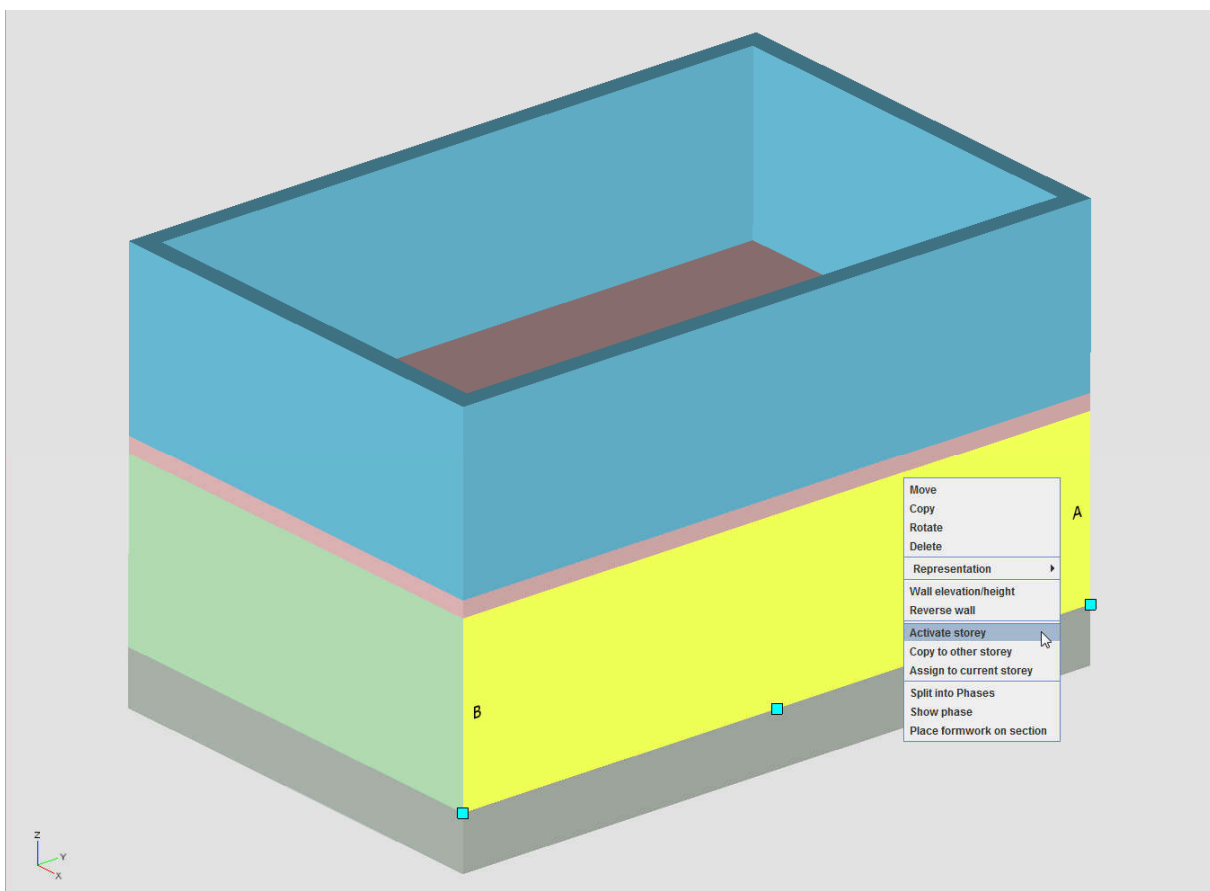

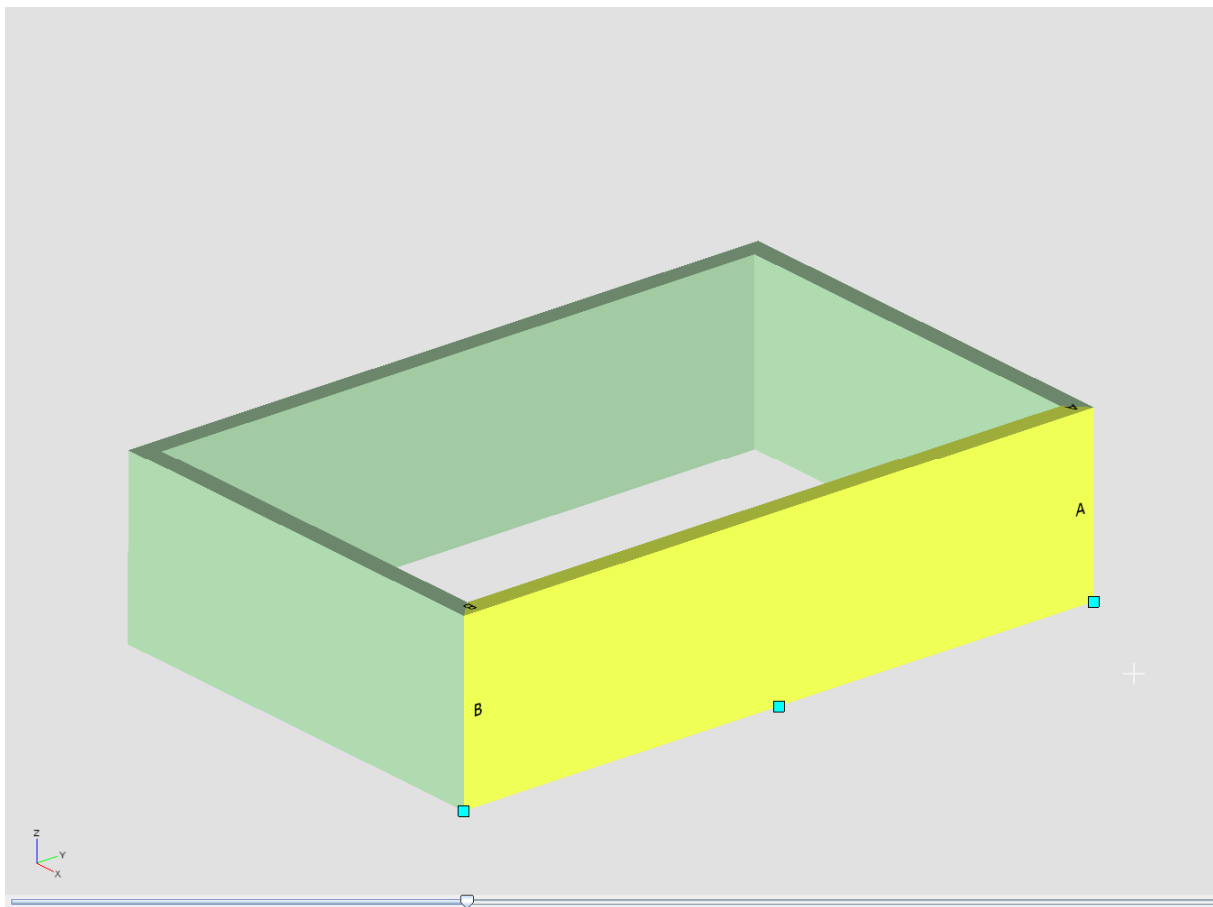

„F9“ Property Filter

When you press the "F9" key, the properties filter is activated. After that you can switch between the PPL Toolbox and the property filter in the lower area:

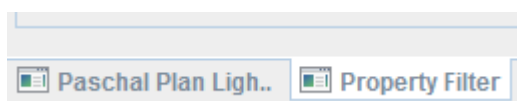
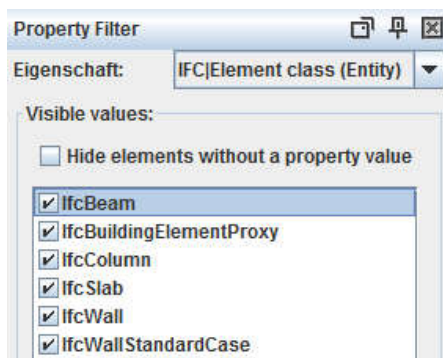

„Esc“ Stop command

To cancel a command or stop a function, press the button "Esc":

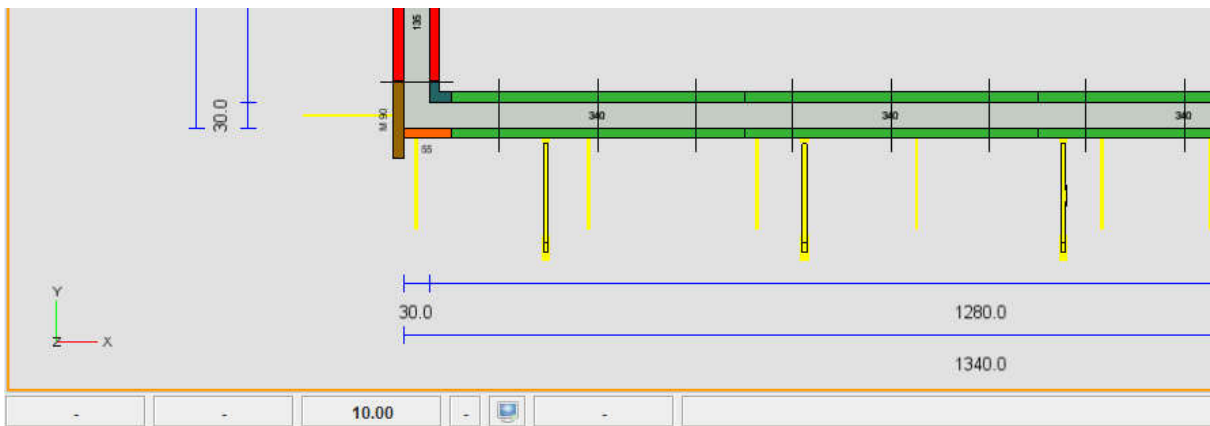
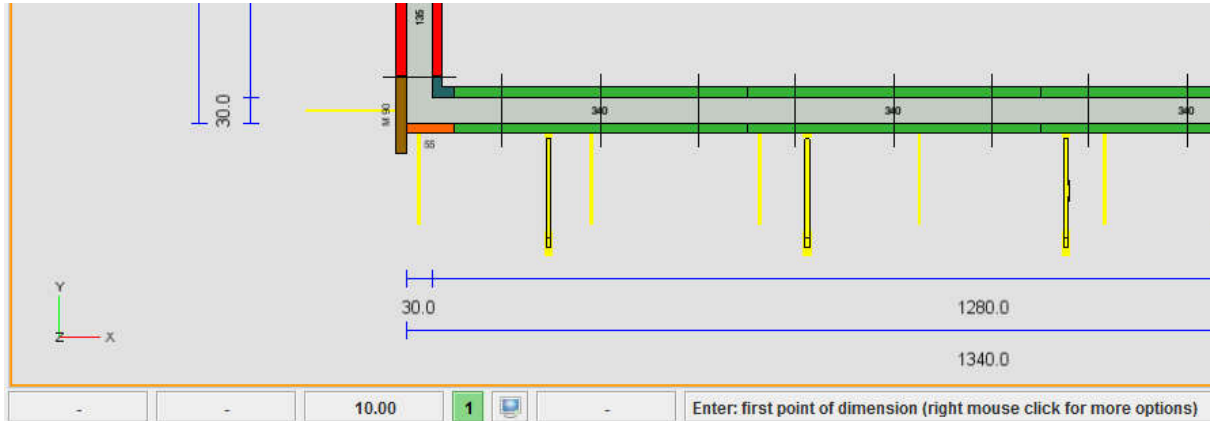
**„Strg+R“ Regen**

When you press the keyboard shortcut "CTRL + R" all the elements of the drawing are displayed anew or redrawn.

„Strg+Y“ Redo

Using the keyboard shortcut "CTRL + Y", you can retrieve the last action deleted with "Undo".

„Strg+Z“ Undo

Using the keyboard shortcut "CTRL + Z", delete the last action performed and undo the last command.

„Strg+M“ Calculate material list

When you press the keyboard shortcut "CTRL + M" a material list is calculated and the appearance changes from the drawing view to the list of materials:

1000 Lines per page



Formwork plan **Material list** Shortage Phase Info Wall Phase Info Slab

Article	Description	Total	Phase 1	Item	Drawing N...
*	*	*	*	*	*
176.001.0450	Logo.3 panel 45x2...	4	4		91-1-4
176.001.0550	Logo.3 panel 55x2...	4	4		91-1-4
176.001.0750	Logo.3 panel 75x2...	4	4		91-1-4
176.001.1350	Logo.3 midi-panel ...	8	8		91-1-4
176.001.3400	Logo.3 large-size ...	20	20		91-1-4
176.004.0900	Logo.3 multi-purp...	4	4		91-1-4
176.005.0250	Logo.3 inside corn...	4	4		91-1-4
183.500.0014	Assembly and dis...	1	1		91-1-4

„Strg+C“ Copy (according to Windows function)

Checked items can be copied using the key combination "CTRL + C".

„Strg+X“ Cut (according to Windows function)

Using the keyboard shortcut "CTRL + X", enabled elements can be cut out or deleted.

„Strg+V“ Insert (according to Windows function)

Checked items can be inserted using the keyboard shortcut "CTRL + V".

„Delete“ Delete

To delete a highlighted item, press the button "Delete".

„S“ oder „C“ Single wall or continuous drawing

To draw single walls individually, select the Wall function and press the "S" key.
To draw walls continuously again press the "C" key.

„P“ Drawing walls with polar coordinates

First select the Wall function and set a starting point. Then press the "P" key. After entering the desired length and angle, confirm with "OK".

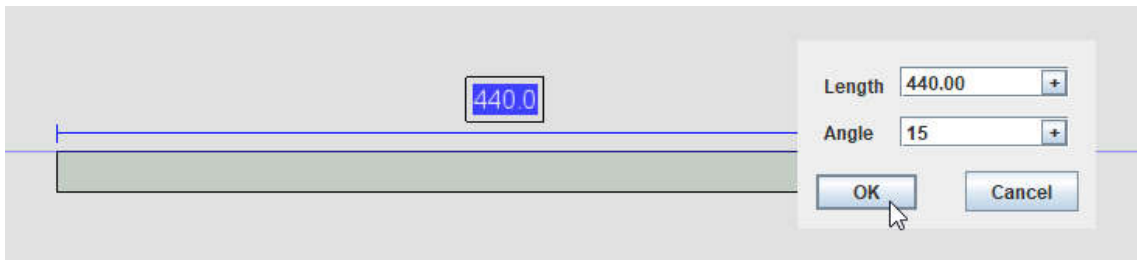

„R“ Drawing walls with relative coordinates

First select the Wall function and set a starting point. Then press the "R" key. After entering the desired values, confirm with "OK".

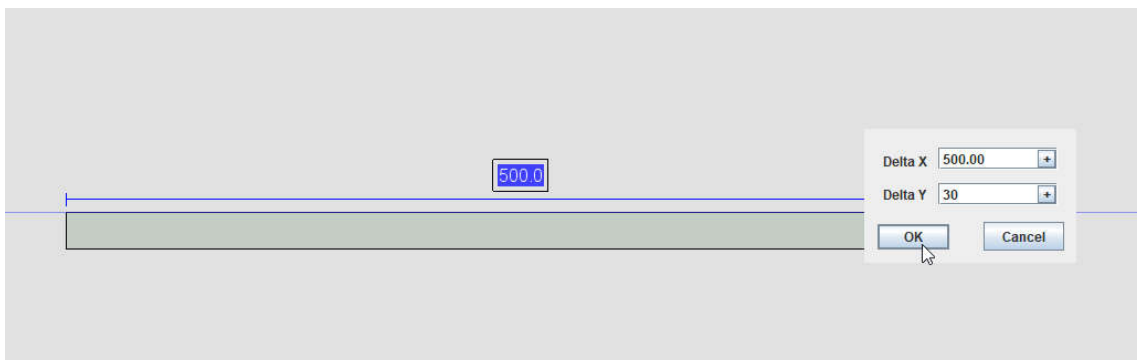

„A“ Drawing walls with absolute coordinates

First select the Wall function and set a starting point. Then press the "A" key. After entering the desired values, confirm with "OK".

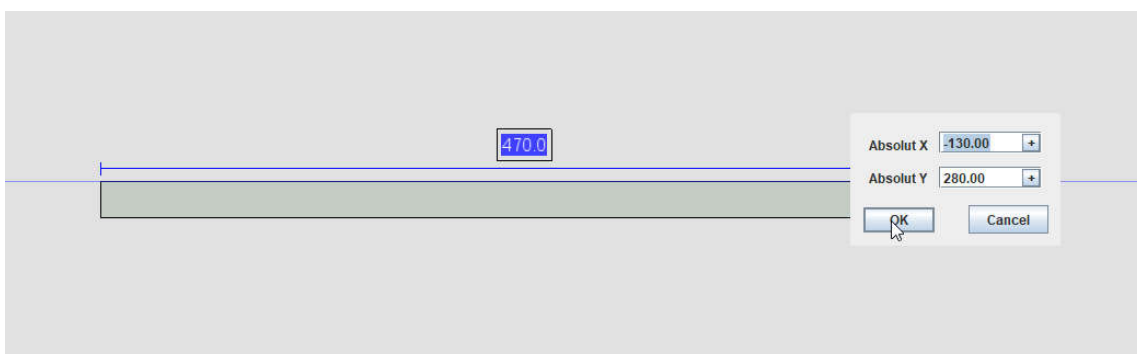

„T“ Subsequently move the endpoint freely

To move an endpoint of an existing wall freely, activate the respective endpoint. Then press the "T" button and click the desired destination.

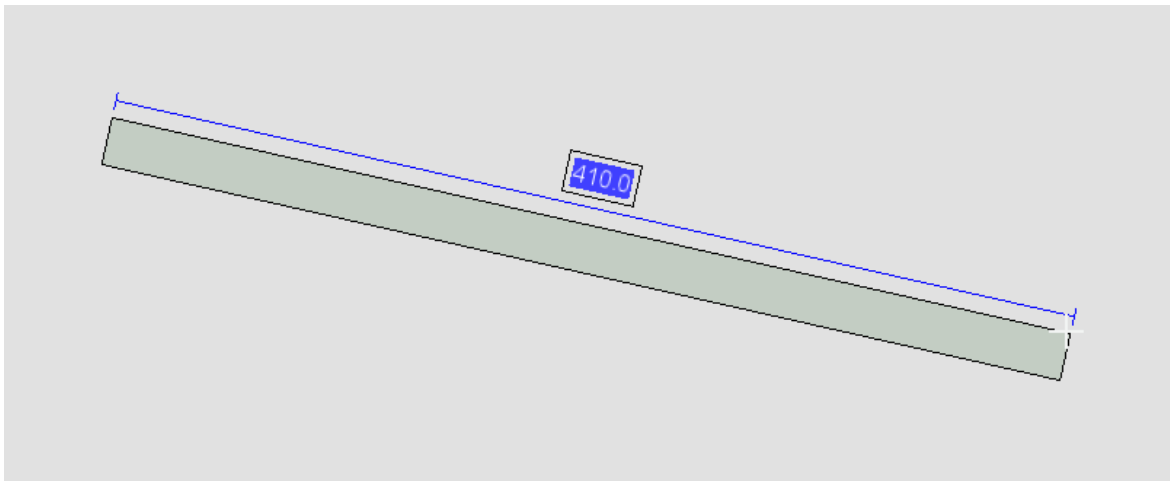
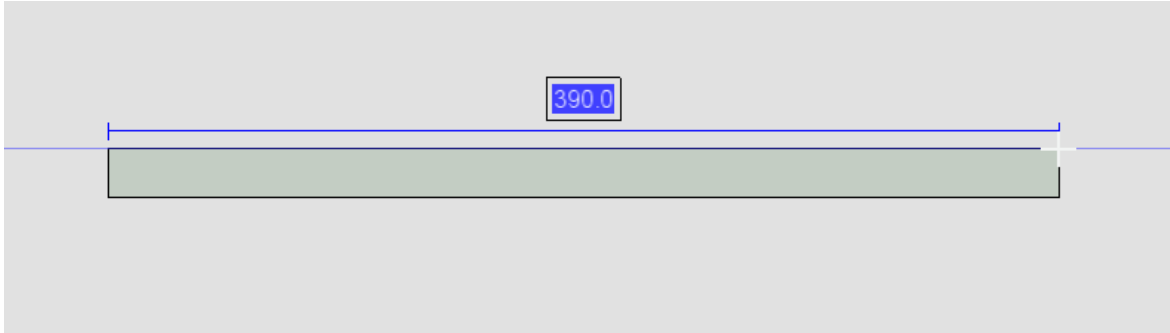
**„T“ + „P“ Subsequently move the endpoint freely with polar coordinates**

To do this, activate the respective endpoint as described above. Then press the "T" key and then "P". After entering the desired values, confirm with "OK"

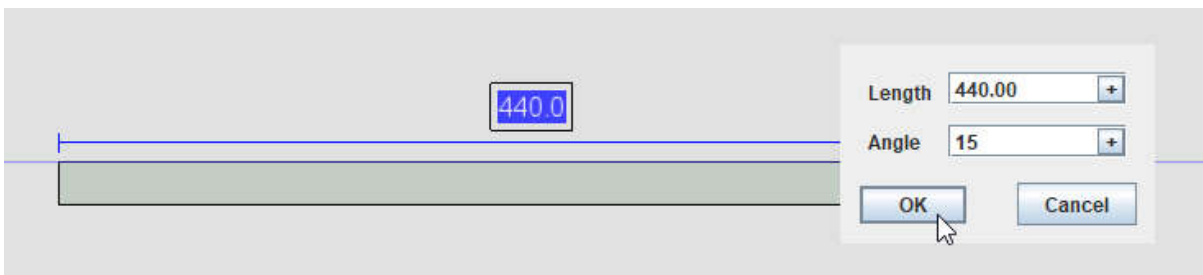

„T“ + „R“ Subsequently move the endpoint freely with relative coordinates

To do this, activate the respective endpoint as described above. Then press the "T" key and then "R". After entering the desired values, confirm with "OK"

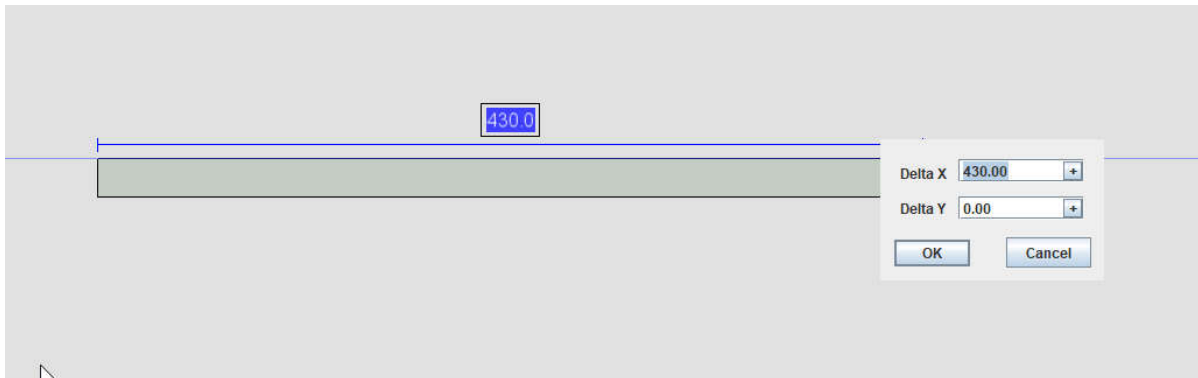
**„T“ + „A“ Subsequently move the endpoint freely with absolute coordinates**

To do this, activate the respective endpoint as described above. Then press the "T" key and then "A". After entering the desired values, confirm with "OK"

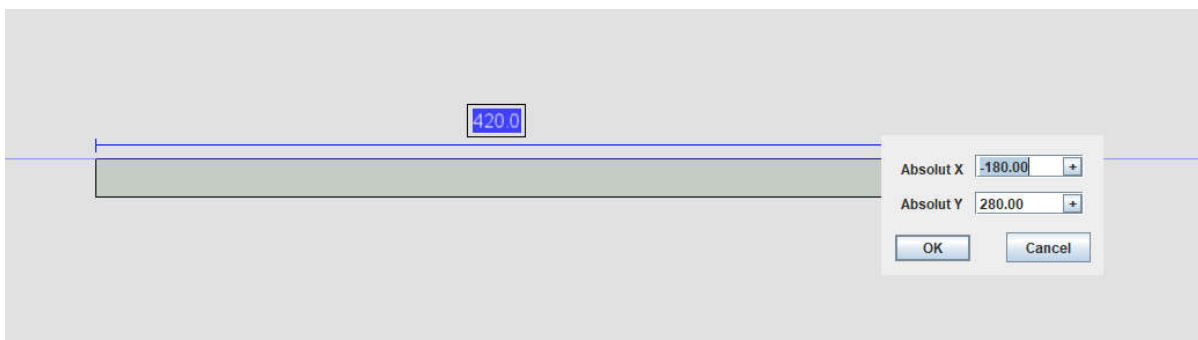

Corresponding special keys and functions also apply when drawing lines.

„Strg+A“ to enable viewport

Using the keyboard shortcut "CTRL + A", a selected plan window is activated in the plan manager:

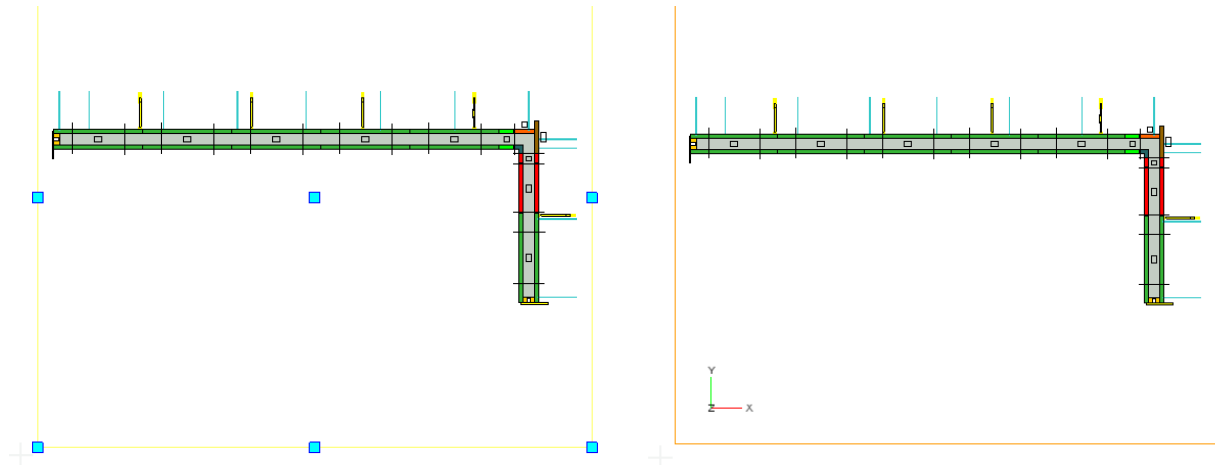
**„Strg+D“ to disable viewport**

The keyboard shortcut "CTRL + D" disables the activated plan window in the plan manager:

